

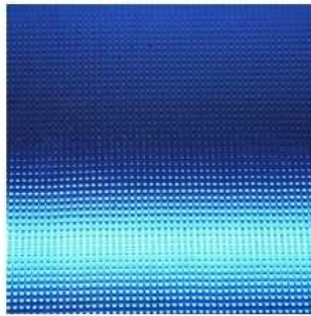

Vertically Integrated Systems

Product Catalog

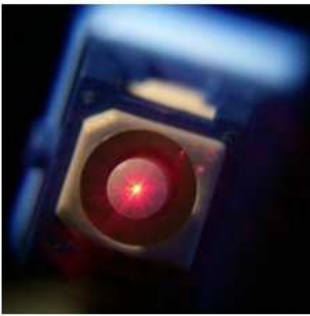

Fiber Optics Components
and Services

2022



Vertically Integrated Systems

Welcome

VI Systems GmbH (VIS) is a developer and manufacturer of optoelectronic components for optical communication, consumer and automotive applications. In the field of optical communications VIS offers optical components, such as vertical cavity surface-emitting lasers (VCSELs) and PIN photodiodes capable of up to 224 Gbps per channel and beyond. VIS VCSEL driver and PIN amplifier integrated circuits operate up to 56 Gbps with NRZ modulation. The latest generation of VCSEL and PIN photodiodes allow 400 Gbps PAM-4 energy efficient data transmission over one fiber with four channel short wave division multiplexing (SWDM) at 850 / 880 / 910 and 940 nm wavelength.



Table of Content

Introduction	4
Fabless Company Concept	5
Services for optical component technology	
Integrated Optical Solutions.....	6
Wafer mapping services.....	7
High frequency test and characterization.....	8
Optical and mechanical measurements	9
Modelling and simulation	10
Fiber coupled VCSEL transmitters (850/880/910 and 940 nm)	
up to 56 Gbps PAM-4 single channel module.....	11
up to 112 Gbps PAM-4 single channel module.....	12
Fiber coupled VCSEL transmitters (1550nm)	
up to 30 Gbps NRZ single channel module.....	13
Fiber coupled photodetectors and receiver modules	
up to 56 Gbps NRZ single channel receiver.....	14
up to 112 Gbps PAM-4 photodetector module.....	14
VCSEL driver ICs	
up to 56 Gbps NRZ single channel driver.....	16
Transimpedance amplifier ICs	
up to 56 Gbps NRZ single channel driver.....	17
VCSEL and PIN photodetector chips	
850/880/910/940 nm VCSEL for up to 112 Gbps PAM-4.....	18
840 - 1650 nm PIN PD for up to 112 Gbps PAM-4.....	19



Vertically Integrated Systems

Company Introduction

VI Systems GmbH (VIS), is a fabless developer and manufacturer of ultrafast cost-effective optoelectronic devices for short reach optical communication interconnects and optical sensor applications. The company is located in center of Berlin - Charlottenburg, Germany in close proximity to leading research institutes and academic technical institutions.



Photo of the building at Hardenbergstr. 8 in Berlin. The company occupies two floors in the upper part of the building including a technical zone with electro-static-damage (ESD) protected work areas.

VI Systems GmbH offers optical subassemblies and fiber coupled modules for applications in optical data communications and optical sensing. In contrast to current optical- and electrical-based technologies, the optical solutions based on VIS components and systems will overcome the rising technological barriers created by the market driven continual increase in optical data transmission rates. With VIS proprietary solutions, telecom and computer equipment manufacturers will be able to meet the continuously growing performance requirements of the future.

Based on the Company's advanced proprietary technology, innovative design concepts, and technical expertise, VIS devices offer a unique combination of high speed, low power consumption, reliability, and low cost. VI Systems' uniqueness is based on its revolutionary concept of vertically-integrated modulator systems a new concept in ultrahigh-speed optical signal transmission and the integration into a low cost fiber optics components.

The company offers a range of optical components, integrated circuits and highly optimized packaging solutions as well as engineering services.

Foundry based operation model

VI Systems designs and manufacturer optical components with the leading foundries in the world. Therefore the reliability of the process and the scalability is ensured from the very early stage of the development. Crucial steps in design and product verification are performed in-house. VI Systems operates a wafer inspection facility and a high speed test and device characterization laboratory in Berlin, Germany.

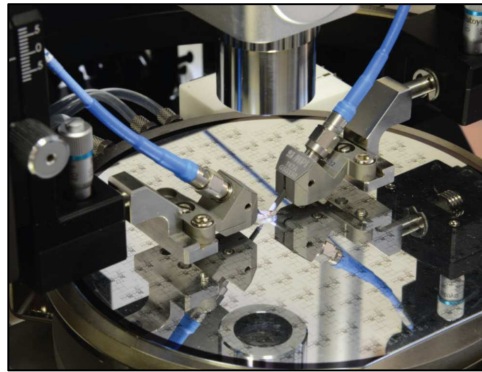

Photo: Wafer inspection systems at VI Systems

VI Systems concentrates on the design and qualification of ultrahigh-speed components for data transmission and high accuracy optical sensors. The manufacturing of optical components, integrated circuits and optical packaging is outsourced to foundries and electronics manufacturing service companies.

Our optical components and integrated products are sold to major manufacturing companies, who then use these components to produce high speed optical modules which are the basis of virtually all optical data transmitting systems.

VI Systems leads a trend in the fiber optic communications industry where manufacturers increasingly seek to outsource production to specialized foundries in order to reduce overall costs and accelerate time to market.

Integrated Optical Solutions

A novel concept of integrated ultrahigh-speed components is introduced by VI Systems. State-of-the-art SiGe BICMOS integrated circuits are customized to match the performance of ultrahigh-speed optical VCSEL transmitter and PIN receiver components. Both key elements are assembled in a proprietary high frequency design to delivery outstanding performance over a wide temperature range.

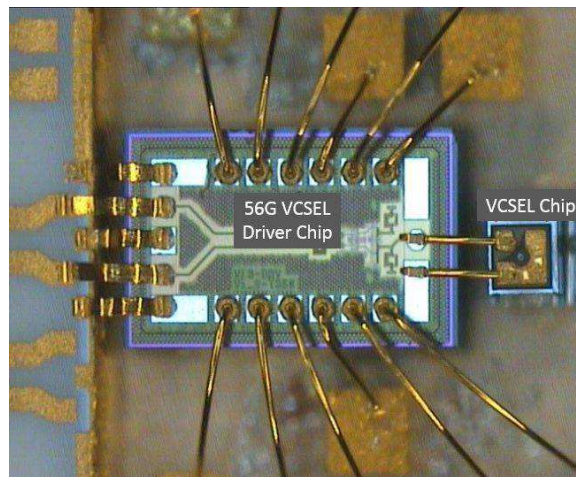

Photo: single channel 56G NRZ VCSEL driver with VCSEL chip

VI Systems offers a range of subcomponents for the use in short reach optical interconnects. The optical engines offer a unique combination of high speed, low power consumption, small footprint, high reliability and low cost.

VI Systems' unique selling point is based on a combination of its revolutionary concept of ultra-high frequency small footprint micro-assembly integration of advanced electro-optic components, development of advanced high speed ICs and development of modulation approaches.

Services for optical component technology

Wafer mapping services

VI Systems new semi-automatic wafer prober station performs high-speed electrical and optical testing of wafers early in the manufacturing process. The system reduces manufacturing costs by eliminating out of specification wafers before they have been cut and packaged to improve yield.

We offer 100% wafer characterization of 2" to 8" wafer using an alignment camera with pattern recognition with automatic alignment to the chips. The test temperature to ranges from 25°C to 150°C. Measurement of L/I/V parameters, threshold current, slope efficiency, measurements of optical spectrum, photodiode sensitivity, reverse bias and dark current.

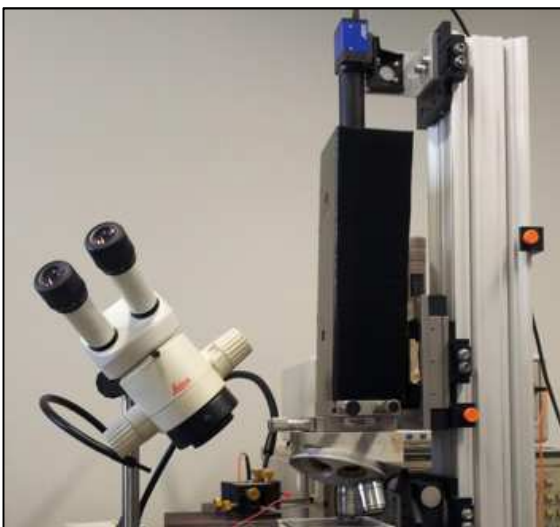

Photo: camera system for farfield studies

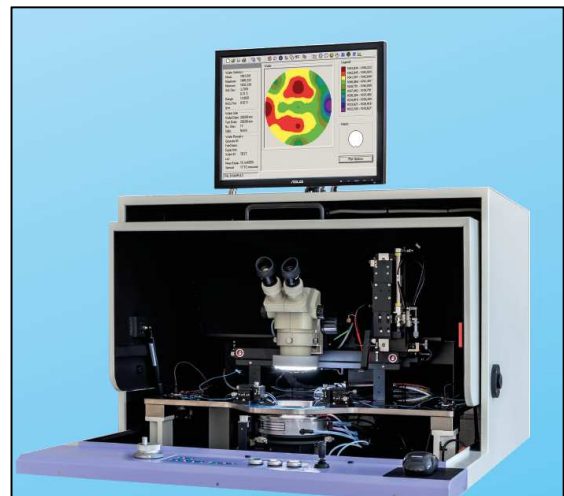

Photo: automatic wafer prober equipment

Testing of optical emission characteristics

Our test station setup allows nearfield and farfield analysis of light emitting devices at temperatures of up to 150°C with a special interference-free infrared optics and camera

Nearfield measurements are performed to determine emitting diameter and mode emission characteristics as well as the measurement of mode field diameter and polarization characteristics.

Farfield measurements provide information on the angular distribution of power and the overall emission characteristics as well as the maximum emission angle.

Services for optical component technology

High frequency test services

Our high frequency test laboratory allows a detailed analysis of the electro-optical performance of chip level devices. For general bandwidth measurement a sine wave frequency generator for up to 38 GHz can be combined with a 70 GHz sampling oscilloscope. For optical test a 32 GHz detector for 700nm to 1600nm is available.

Specific optical data modulation characteristics and eye-diagram measurements of up to 128 Gbit/s can be performed. Our bit pattern generator generates a range of standard pseudo random bit sequences such as PRBS7 and PRBS31. For high speed test of short reach application at 850nm wavelength a range photodetector and photoreceiver modules with for up to 112 Gbit/s are available.

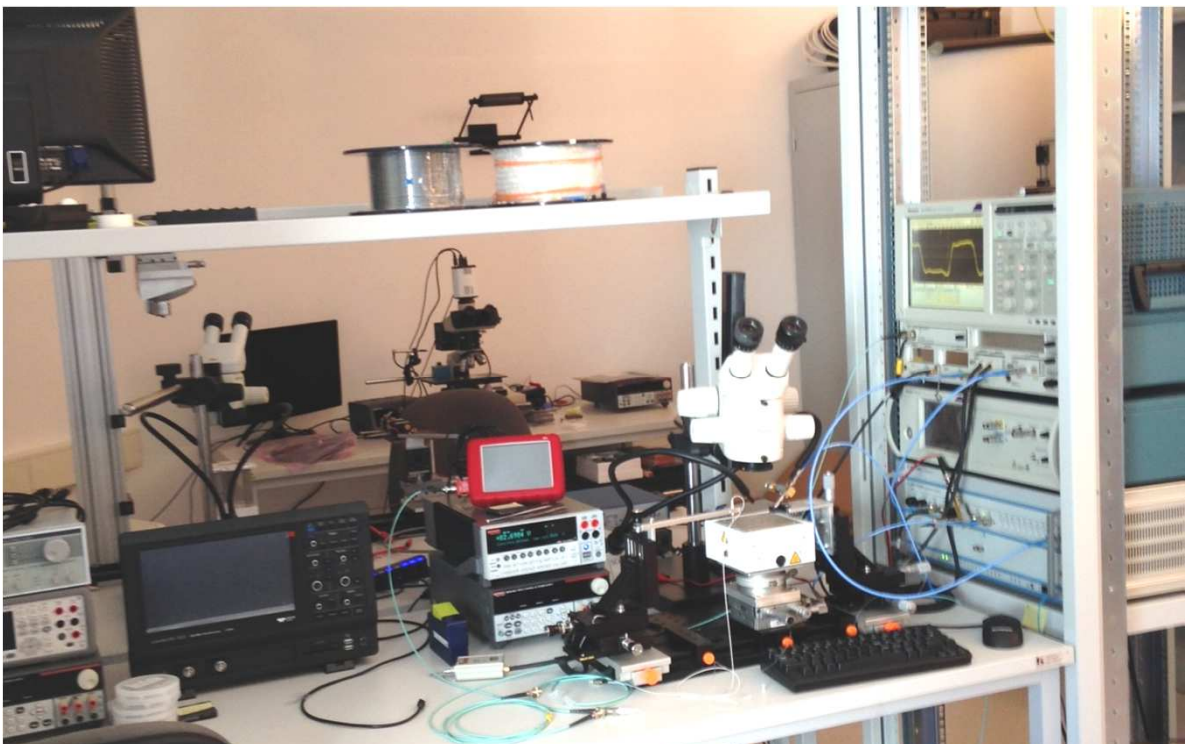

Photo: high frequency test laboratory for data transmission experiments

Services for optical component technology

Optical and Mechanical Inspection

We offer a range of inspection tools to determine the the properties of optical components. Our laboratory is equipped with conventional optical microscopes with a magnification of up to 1000 times.

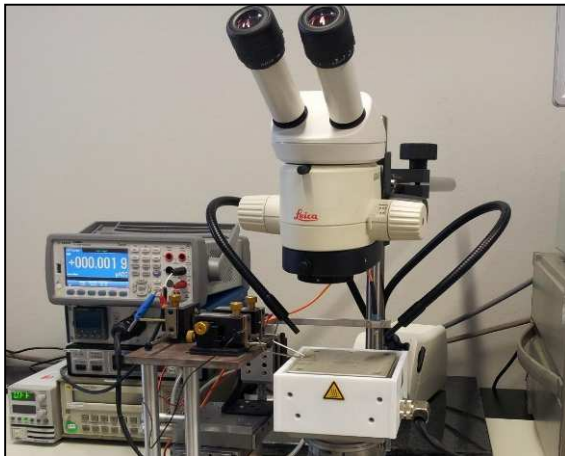

Photo: stereo microscope with temperature chuck

More complex studies using focused ion beam (FIB), scanning electron microscopy (SEM) and transmission electron microscopy (TEM) are performed with external test partners

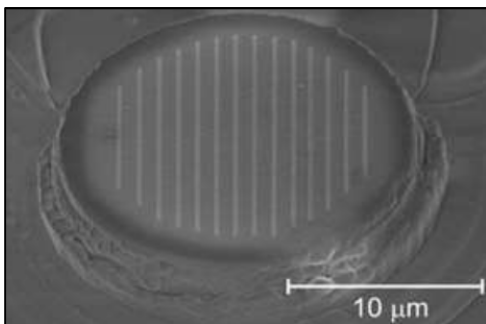

Image: structure analysis with TEM

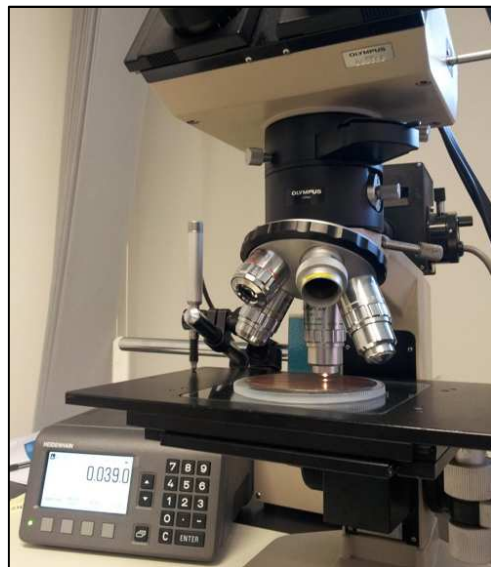

Photo: high resolution optical microscope

With our thickness analysis technology we can determine horizontal dimensions with resolution of 0.1 μm and vertical dimensions with a resolution of 0.5 μm .

Testing of VCSEL, LED, PD, APD

Our microprober station allows on-wafer characterization test in a wide temperature rang. For static test we can measure electrical charateristics such as forward and reverse voltage or current and differential resistance. Optical test characteristics include paramters such As power, spectrum, sensitivity, efficiency, threshold current, slope efficiency and amplification

Services for optical component technology

Thermal analysis

Simulation tools for the thermal modeling of semiconductor packages have now become routine in most design processes. From early spreadsheet-type tools that were in vogue a couple of decades ago, many designers now use sophisticated FEA (Finite Element Analysis) or CFD (Computational Fluid Dynamics) tools, and interface their mechanical CAD data directly into their analysis.

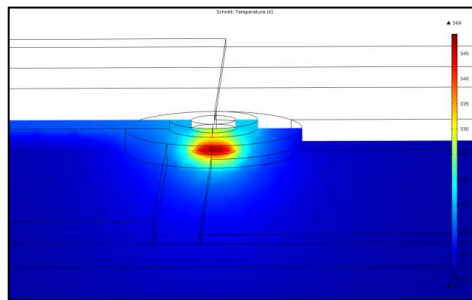

Image: Thermal distribution in a VCSEL

Modelling and simulation

VCSELs are key components for optical interconnects and are widely applied in high-performance computers and data centers. Single transverse-mode VCSELs are used in sensing, illumination, and display applications. The image below shows a cross section of the simulated electric field of the fundamental and first excited optical modes of an oxide-confined aluminum gallium arsenide-based leaky VCSEL.

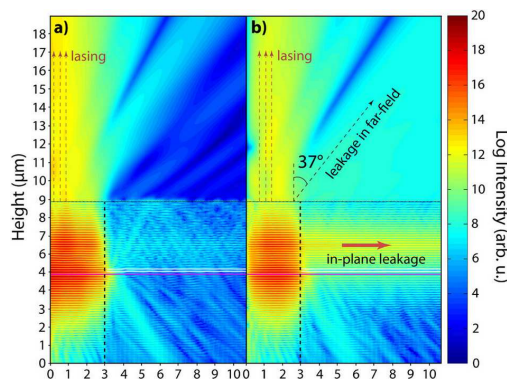

Image: Radial distribution of the simulated electric field of oxide-confined leaky vertical-cavity surface-emitting laser (VCSEL) optical modes. (a) Fundamental optical mode. (b) First excited mode.

VCSEL transmitter modules

V25-850M

Transmitter Module (up to 28 Gbps NRZ)



Parameter	Typical
Emission Wavelength	850 nm
Data rate (NRZ)	28 Gbps
Fiber Type	50/125 μm

V50-850M

Transmitter Module (up to 56 Gbps PAM-4)



Parameter	Typical
Emission Wavelength	850 nm
Data rate (PAM-4)	56 Gbps
Fiber Type	50/125 μm

T56-850

Transmitter subassembly for up to 56 Gbps

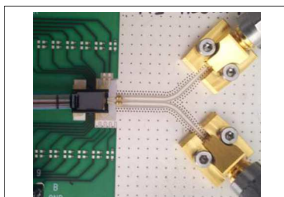

Parameter	Typical
Emitting Wavelength	850 nm
Data rate (NRZ)	56 Gbps
Fiber Type	50/125 μm

VM100-850M

Transmitter Module (up to 112 Gbps PAM-4)



Parameter	Typical
Emission Wavelength	850 nm
Data rate (PAM-4)	112 Gbps
Fiber Type	50/125 μm

VCSEL transmitter module

VM100-880M

Transmitter Module for up to 112 Gbps PAM-4



Parameter	Typical
Emission Wavelength	880 nm
Data rate (PAM-4)	112 Gbps
Fiber Type	50/125 μm

VM100-910M

Transmitter Module for up to 112 Gbps PAM-4



Parameter	Typical
Emission Wavelength	910 nm
Data rate (PAM-4)	112 Gbps
Fiber Type	50/125 μm

VM100-940M

Transmitter Module for up to 112 Gbps PAM-4



Parameter	Typical
Emission Wavelength	940 nm
Data rate (PAM-4)	112 Gbps
Fiber Type	50/125 μm

VCSEL transmitter module (long wavelength)

V30-1550M Transmitter Module (up to 30 Gbps NRZ)



Parameter	Typical
Emission Wavelength	1550 nm
Data rate (NRZ)	30 Gbps
Fiber Type	9/125 μm

Optical receiver and photodetector modules

R50-850

Receiver subassembly for up to 56 Gbps

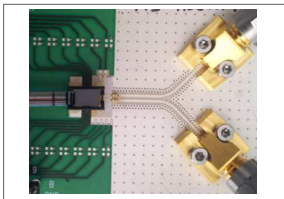

Parameter	Typical
Input wavelength	700 - 870 nm
Data rate (NRZ)	56 Gbps
Fiber Type	50/125 μ m

D30-850M

Photodetector Module for up to 112 Gbps



Parameter	Typical
Input wavelength	840 - 1650 nm
Data rate (PAM-4)	112 Gbps
Fiber Type	50/125 μ m

VCSEL Driver ICs

A56-230C High Speed VCSEL driver

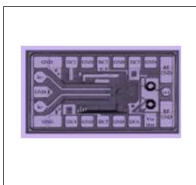

Parameter	Typical
Data rate	up to 56 Gbps
Supply voltage	3.3 V
Power dissipation	230 mW

A56-105C High Speed VCSEL driver

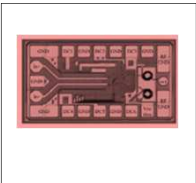

Parameter	Typical
Data rate	up to 56 Gbps
Supply voltage	3.3 V
Power dissipation	105 mW

A56-xxxC_DRV_TB VCSEL driver evaluation board

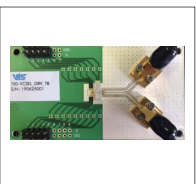

Parameter	Typical
Data rate (NRZ)	up to 100 Gbps
Supply voltage	3.3 V
Power dissipation	230 mW

Transimpedance Amplifier (TIA)

T56-250C_V1.1
High Speed TIA

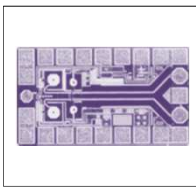

Parameter	Typical
Supply voltage	3.3 V
Data rate (NRZ)	56 Gbps
Power dissipation	250 mW

T56-250C_V1.2
High Speed TIA

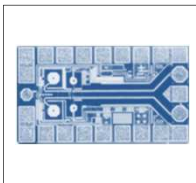

Parameter	Typical
Supply voltage	3.3 V
Data rate (NRZ)	56 Gbps
Power dissipation	250 mW

T56-150C_2.0
High Speed TIA

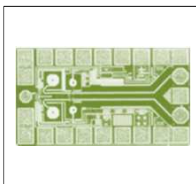

Parameter	Typical
Supply voltage	3.3 V
Data rate (NRZ)	56 Gbps
Power dissipation	150 mW

VCSEL Chips (850nm and SWDM)

V25-850C High-Speed VCSEL Chip

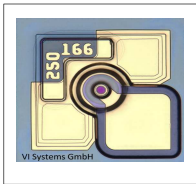

Parameter	Typical
Emission Wavelength	850 nm
Peak Output Power	4 mW
Data rate (NRZ)	28 Gbps

V50-850C High Speed VCSEL Chip

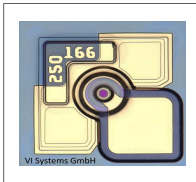

Parameter	Typical
Emission Wavelength	850 nm
Peak Output Power	4 mW
Data rate (NRZ)	56 Gbps

VM100-xxxC High Speed VCSEL Chip



Parameter	Typical
Emission Wavelength	850 / 880 / 910 / 940 nm
Peak Output Power	4 mW
Data rate (PAM-4)	112 Gbps

V4M100-xxxC High Speed VCSEL mini array Chip



Parameter	Typical
Emission Wavelength	850 / 880 / 910 / 940 nm
Peak Output Power	3 mW
Data rate (PAM-4)	112 Gbps

Broad Range Photodetector PIN Diode

Dxx-BROAD-Cxx High Speed Photodetector



Parameter	Typical
Operating Wavelength	800-1650 nm
Bandwidth	~ 40 GHz
Available chip type	1-ch / 4-ch



Vertically Integrated Systems

VI Systems GmbH

Hardenbergstrasse 7
10623 Berlin, Germany
Tel.: +49 30 3083143 30
Fax: +49 30 3083143 59
sales@v-i-systems.com
www.v-i-systems.com

 <https://twitter.com/visGmbH>

 <https://www.linkedin.com/company/vi-systems-gmbh>

All product specifications and descriptions are subject to change without notice.
Please contact our sales department for additional information and to receive a quotation: sales@v-i-systems.com